

isc Silicon NPN Darlington Power Transistor

2SD1602

DESCRIPTION

- Collector-Emitter Breakdown Voltage-
: $V_{(BR)CEO} = 80V(\text{Min})$
- High DC Current Gain
: $h_{FE} = 1000(\text{Min}) @ I_C = 2A$
- Complement to Type 2SB1102

APPLICATIONS

- Designed for low frequency power amplifiers applications.

ABSOLUTE MAXIMUM RATINGS($T_a = 25^\circ\text{C}$)

SYMBOL	PARAMETER	VALUE	UNIT
V_{CBO}	Collector-Base Voltage	80	V
V_{CEO}	Collector-Emitter Voltage	80	V
V_{EBO}	Emitter-Base Voltage	7	V
I_C	Collector Current-Continuous	4	A
I_{CP}	Collector Current-Peak	8	A
P_C	Collector Power Dissipation @ $T_C = 25^\circ\text{C}$	40	W
T_J	Junction Temperature	150	$^\circ\text{C}$
T_{stg}	Storage Temperature Range	-55~150	$^\circ\text{C}$

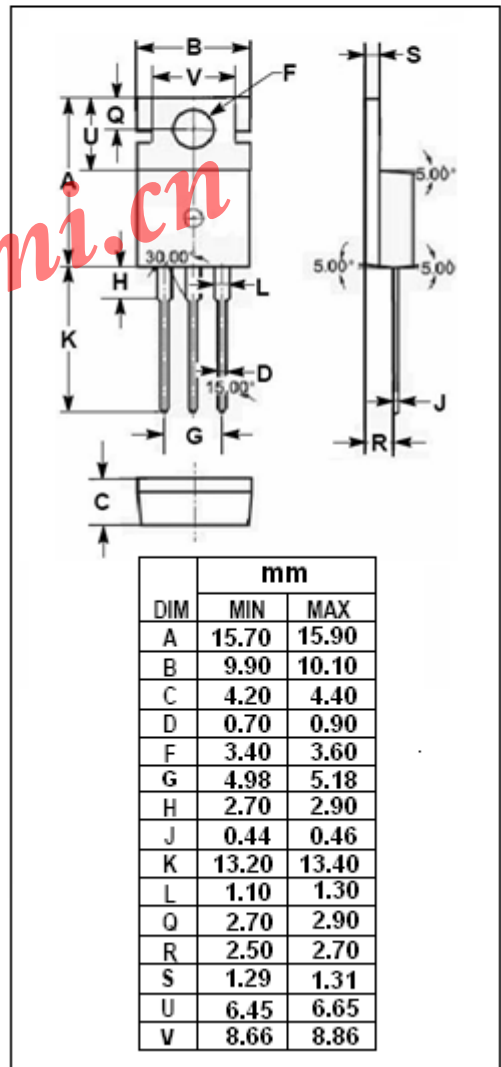
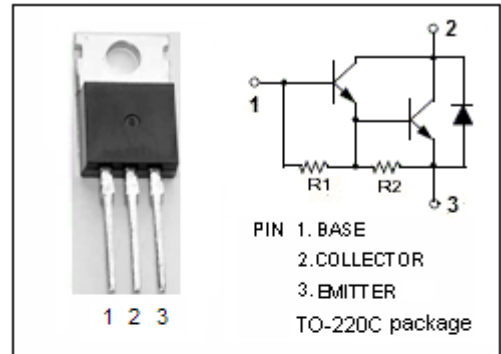

isc Silicon NPN Darlington Power Transistor

2SD1602

ELECTRICAL CHARACTERISTICS

$T_C=25^{\circ}\text{C}$ unless otherwise specified

SYMBOL	PARAMETER	CONDITIONS	MIN	TYP.	MAX	UNIT
$V_{(BR)CEO}$	Collector-Emitter Breakdown Voltage	$I_C= 25\text{mA}; R_{BE}= \infty$	80			V
$V_{(BR)EBO}$	Emitter-Base Breakdown Voltage	$I_E= 50\text{mA}; I_C= 0$	7			V
$V_{CE(sat)-1}$	Collector-Emitter Saturation Voltage	$I_C= 2\text{A}; I_B= 4\text{mA}$			1.5	V
$V_{CE(sat)-2}$	Collector-Emitter Saturation Voltage	$I_C= 4\text{A}; I_B= 40\text{mA}$			3.0	V
$V_{BE(sat)-1}$	Base-Emitter Saturation Voltage	$I_C= 2\text{A}; I_B= 4\text{mA}$			2.0	V
$V_{BE(sat)-2}$	Base-Emitter Saturation Voltage	$I_C= 4\text{A}; I_B= 40\text{mA}$			3.5	V
I_{CBO}	Collector Cutoff Current	$V_{CB}= 60\text{V}; I_E= 0$			100	μA
I_{CEO}	Collector Cutoff Current	$V_{CE}= 50\text{V}; R_{BE}= \infty$			10	μA
h_{FE}	DC Current Gain	$I_C= 2\text{A}; V_{CE}= 3\text{V}$	1000		20000	
V_{ECF}	C-E Diode Forward Voltage	$I_F= 4\text{A}$			3.0	V

Switching times

t_{on}	Turn-on Time	$I_C= 2\text{A}, I_{B1}= -I_{B2}= 4\text{mA}$		1.0		μs
t_{stg}	Storage Time			6.0		μs
t_f	Fall Time			1.0		μs